

Tri Color LED Electronic Switch

IP 69K 15Amp DT Connector

Features

- ▶ One channel 15 Amp max. Electrical Rating.
- ▶ Two channels 7.5 Amp max. /Channel Electrical Rating.
- ▶ At night every switch is backlit with Blue LED light for great visibility. Turn on a particular function and the LED turns Red letting you know the function is turned on.
- ▶ Stainless Steel SS316 Body and IP69K Waterproof Rating.
- ▶ Protection from Salt Spray.
- ▶ 20g Bump Shock Test Approved.
- ▶ Wires/Switch meet Flammability Rating UL 94 V2 and
- ▶ All material will be non-flammable or will be 105°C spec. When the pump is running, the LED turns red automatically

Specification

Illuminated	Blue , Green & Red LED
Voltage Rating	12VDC ~ 24VDC
Max. Current	15 Amp
Mechanical Life	50,000 Cycles
Electrical Life Contact	10,000 Cycles
Resistance Insulation	50 mΩ Maximum
Resistance	1000mΩ Minimum
Dielectric Strength	2,000 VAC
Operate Storage Temp	-20°C ~ +55°C
Travel	1.50mm
Moisture Protection	IP69K
Contact Material	Silver Alloy
Actuation Force	4 N
Panel Thickness	1-6mm
Mounting Nut Torque	5-14Nm
Construction Material	
Body Material	Stainless Steel SS316
Lens Material	PC material rated to 105°C
Switch Plug & Dongle	Nylon 6 rated to 105°C
Deutsch Recommended Part#	
Large socket	0462-203-12141
Small socket	0462-209-16141
Dummy Plug	14017-ZZ

Recommended Wiring

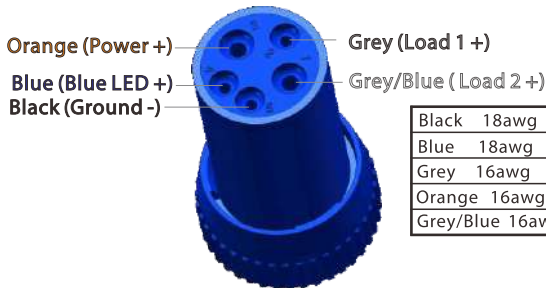

Black 18awg	Ground -
Blue 18awg	Blue LED +12Vdc
Grey 16awg	Load1 +12Vdc
Orange 16awg	Power +12Vdc
Grey/Blue 16awg	Load2 +12Vdc

Mounting Hole

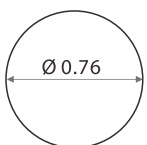

Warning !!

- ▶ Permanent Failure will occur if any power and ground leads are shorted together on the switch.
- ▶ Only use Bluewater DT connector, other connector will cause damage.

Part No.

Function	Parts No.	LED Color			Rear Mark Page
		Off	1st On	2nd On	
Off-On	9057-1113	(Blue)	Red	✗	Red dot
	9057-1123	(Green)	Blue	✗	
Off-(On)	9057-2113	(Blue)	Red	✗	Green dot
	9057-2133	(Green)	Blue	✗	
Off-(On) - (On)	9057-2123	(Blue)	Green	Red	Green dot with a Line
	9057-2223	(Green)	Blue	Red	
Off-On-On	9057-3113	(Blue)	Green	Red	Blue dot
	9057-3123	(Green)	Blue	Red	
Nav/Anc	9057-3114	(Blue)	Green	Red	White dot
Dimmer	9057-3116	(Blue)	Red	✗	Black dot
Switch Plug	9057-4914	5 pin Deutsch Plug			

Replaceable Push Button Actuator

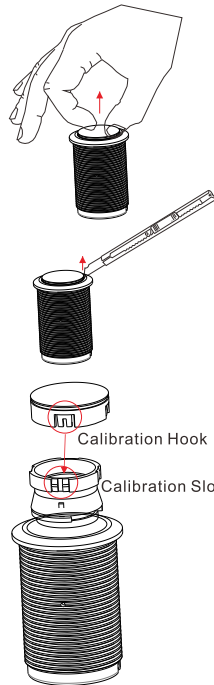

Style	Parts No.
Full Translucent	9551-1001
SS Ring	9551-1002
SS Ring (Black)	9551-1003
SS Ring (Titanium)	9551-1004
Laser Logo (Blank)	9551-1005
Laser Logo (Red)	9551-1019
Laser Logo (Cust) Custom Text	9551-0001~ -0188

Standard Legend Imprinting Code : Page 6

Size Diagram

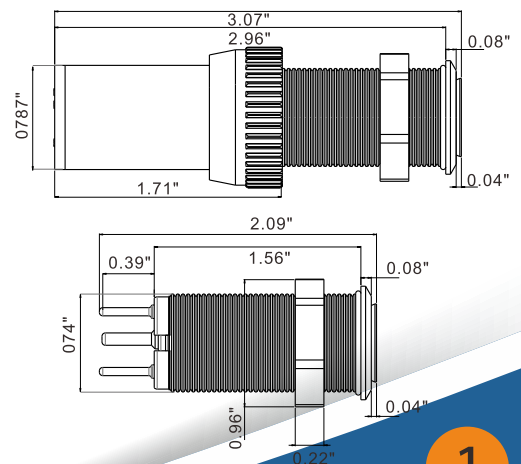

* We reserve the right to change specifications at any time without incurring any obligations!

9057-1113

Off- On

Off - [Blue] On - Red LED

Operation

- ▶ Press turns on the device (LED turns Red) .
- ▶ Press turns off the device (LED turns Blue)



Laser Etched Actuator in **Daytime Mode**
LED light is off.



Laser Etched Actuator in **nighttime Mode**
The Blue LED provides great visibility of the function switches and lets you know that the swithes are in off position .



Laser Etched Actuator in **On Mode**
The Red LED lets you know that the device is on .

Dimming Instruction

- ▶ Press and hold the button for 5 seconds at off mode (Blue LED flash).
- ▶ Press the button to adjust the Blue Backlight level (3 levels)
- ▶ Wait for 3 seconds will set the light level automatically

REAR PLUG VIEW

OFF CAN BE BLUE BACKLIT - APPLY B+ TO TERM 4.
1ST PUSH - LIGHTS RED [LOAD 1 ON]
2ND PUSH - OFF

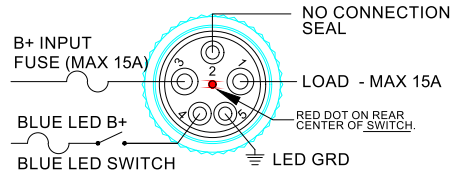

POS 1 & 3 ARE DEUTCH DTP [LARGE] FEM TERM
POS 2, 4, 5 ARE DEUTCH DP [SMALL] FEM TERM

COURTESY LIGHTS EXAMPLE

OFF CAN BE BLUE BACKLIT - APPLY B+ TO 4.
1ST PUSH - LIGHTS RED [COURT LTS ON]
2ND PUSH - OFF

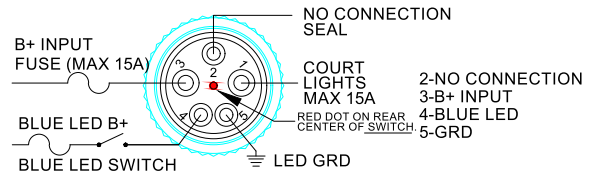

POS 1 & 3 ARE DEUTCH DTP [LARGE] FEM TERM
POS 2, 4, 5 ARE DEUTCH DP [SMALL] FEM TERM

9057-1123

Off- On

Off - [Green] On - Blue LED

Operation

- ▶ Press turns on the device (LED turns Blue) .
- ▶ Press turns off the device (LED turns Green)



Laser Etched Actuator in **Daytime Mode**
LED light is off.



Laser Etched Actuator in **nighttime Mode**
The Green LED provides great visibility of the function switches and lets you know that the swithes are in off position .



Laser Etched Actuator in **On Mode**
The Blue LED lets you know that the device is on .

Dimming Instruction

- ▶ Press and hold the button for 5 seconds at off mode (Green LED flash).
- ▶ Press the button to adjust the Green Backlight level (3 levels)
- ▶ Wait for 3 seconds will set the light level automatically

REAR PLUG VIEW

OFF CAN BE GREEN BACKLIT - APPLY B+ TO TERM 4.
1ST PUSH - LIGHTS BLUE [LOAD 1 ON]
2ND PUSH - OFF

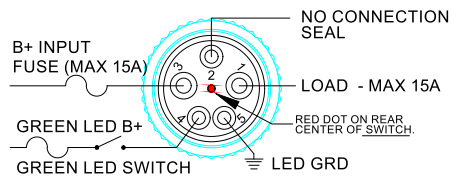

POS 1 & 3 ARE DEUTCH DTP [LARGE] FEM TERM
POS 2, 4, 5 ARE DEUTCH DP [SMALL] FEM TERM

COURTESY LIGHTS EXAMPLE

OFF CAN BE GREEN BACKLIT - APPLY B+ TO 4.
1ST PUSH - LIGHTS BLUE [COURT LTS ON]
2ND PUSH - OFF

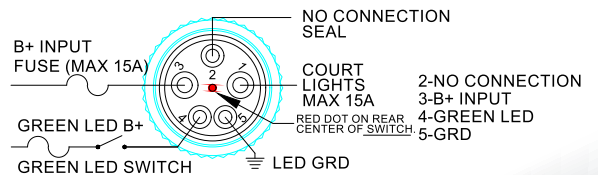

POS 1 & 3 ARE DEUTCH DTP [LARGE] FEM TERM
POS 2, 4, 5 ARE DEUTCH DP [SMALL] FEM TERM

9057-2113

Off- (On)

Off - [Blue] On - Red LED

Operation

- ▶ Press and hold the button to turns on the device (LED turns Red).
- ▶ Release the button to turns off the device (LED turns Blue)



Laser Etched Actuator in **Daytime Mode**
LED light is off.



Laser Etched Actuator in **Nighttime Mode**
The Blue LED provides great visibility of the function switches and lets you know that the swithes are in off position.



Laser Etched Actuator in **On Mode**
The Red LED lets you know that the device is on.

Dimming Instruction

- ▶ Press 6 times and hold the button for 5 seconds at off mode (Blue LED flash).
- ▶ Press the button to adjust the Blue Backlight level (3 levels)
- ▶ Wait for 3 seconds will set the light level automatically

REAR PLUG VIEW

OFF CAN BE BLUE BACKLIT - APPLY B+ TO TERM 4.
MOM PUSH - LIGHTS RED [LOAD 1 MOM ON]
RELEASE - OFF

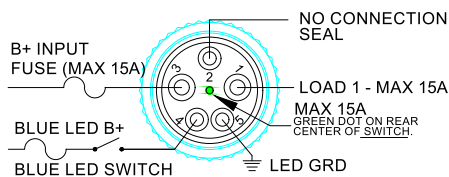

POS 1 & 3 ARE DEUTCH DTP [LARGE] FEM TERM
POS 4, 5 ARE DEUTCH DP [SMALL] FEM TERM
POS 2 SEAL

HORN EXAMPLE

OFF CAN BE BLUE BACKLIT - APPLY B+ TO 4.
MOM PUSH - LIGHTS RED [HORN ON]
RELEASE OFF

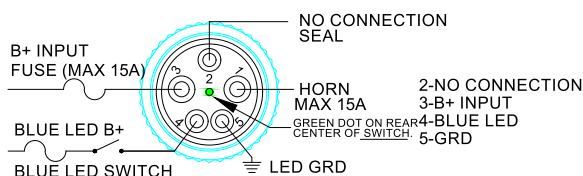

POS 1 & 3 ARE DEUTCH DTP [LARGE] FEM TERM
POS 2, 4, 5 ARE DEUTCH DP [SMALL] FEM TERM

9057-2133

Off - (On)

Off-[Green] - ON- Blue LED

Operation

- ▶ Press and hold the button to turns on the device (LED turns Blue).
- ▶ Release the button to turns off the device (LED turns Green)



PU Dome Backlit label in **Daytime Mode**
LED light is off.



PU Dome Backlit label in **Nighttime Mode**
The Green LED provides great visibility of the function switches and lets you know that the swithes are in off position.



PU Dome Backlit label in **On Mode**
The Blue LED lets you know that the device is on.

Dimming Instruction

- ▶ Press 6 times and hold the button for 5 seconds at off mode (Blue LED flash).
- ▶ Press the button to adjust the Blue Backlight level (3 levels)
- ▶ Wait for 3 seconds will set the light level automatically

REAR PLUG VIEW

OFF CAN BE GREEN BACKLIT - APPLY B+ TO TERM 4.
MOM PUSH - LIGHTS BLUE [LOAD 1 MOM ON]
RELEASE - OFF

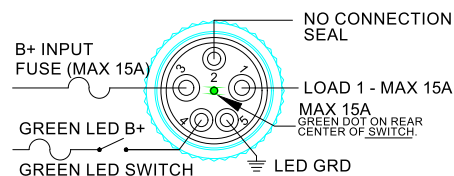

POS 1 & 3 ARE DEUTCH DTP [LARGE] FEM TERM
POS 4, 5 ARE DEUTCH DP [SMALL] FEM TERM
POS 2 SEAL

HORN EXAMPLE

OFF CAN BE GREEN BACKLIT - APPLY B+ TO 4.
MOM PUSH - LIGHTS BLUE [HORN ON]
RELEASE OFF

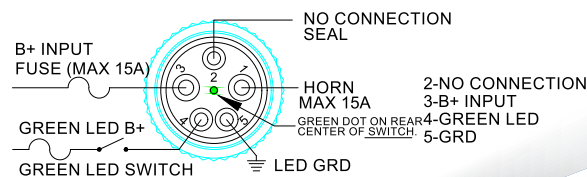

POS 1 & 3 ARE DEUTCH DTP [LARGE] FEM TERM
POS 2, 4, 5 ARE DEUTCH DP [SMALL] FEM TERM

9057-3114 Nav/Anc Switch

OFF-[1 & 2 ON]-[2 ON & 1 OFF]

Operation

- ▶ Press turns on the Navigation & Anchor lights (LED turns Green).
- ▶ Press leaves Anchor light on and turns off Navigation light (LED turns Red)
- ▶ Press turns off Anchor light (LED turns Blue)



PU Dome Backlit label in **Daytime Mode**
LED light is off.



PU Dome Backlit label in **Nighttime Mode**
The Blue LED provides great visibility of the function switches and lets you know that the swithes are in off position .



PU Dome Backlit label in **Nav/Anc Mode**
The Green LED lets you know that the Nav and Anchor switches are in on position .



PU Dome Backlit label in **Anchor Mode**
The Red LED lets you know that the Anchor switch is on .

Dimming Instruction

- ▶ Press and hold the button for 5 seconds at o mode (Blue LED flash).
- ▶ Press the button to adjust the Blue Backlight level (3 levels)
- ▶ Wait for 3 seconds will set the light level automatically

REAR PLUG VIEW

OFF CAN BE BLUE BACKLIT - APPLY B+ TO TERM 4.
1ST PUSH - LIGHTS GREEN [BOTH 1 & 2 LOADS ON]
2ND PUSH - LIGHTS RED [ONLY LOAD 2 ON]
3RD PUSH - OFF

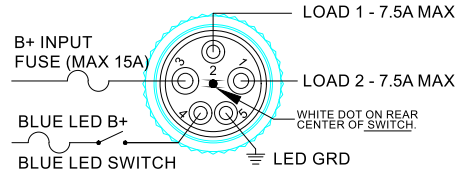

POS 1 & 3 ARE DEUTCH DTP [LARGE] FEM TERM
POS 2, 4, 5 ARE DEUTCH DP [SMALL] FEM TERM

NAV/ANC EXAMPLE

OFF CAN BE BLUE BACKLIT - APPLY B+ TO 4.
1ST PUSH - LIGHTS GREEN [BOTH NAV & ANC LOADS ON]
2ND PUSH LIGHTS RED [ONLY ANC LOAD ON]

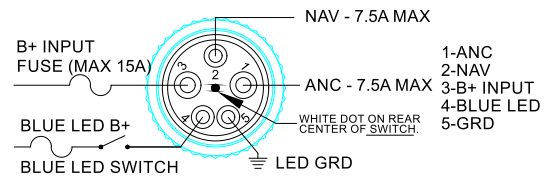

POS 1 & 3 ARE DEUTCH DTP [LARGE] FEM TERM
POS 2, 4, 5 ARE DEUTCH DP [SMALL] FEM TERM

9057-3113 Off-On-On Switch

OFF-[1 ON & 2 OFF]-[2 ON & 1 OFF]

Operation

- ▶ Press turns on Load 1 (LED turns Green) .
- ▶ Press turns on Load 2 (LED turns Red)
- ▶ Press turns off Load 2 & 1 (LED turns Blue)



PU Dome Backlit label in **Daytime Mode**
LED light is off.



PU Dome Backlit label in **Nighttime Mode**
The Blue LED provides great visibility of the function switches and lets you know that the swithes are in off position .



PU Dome Backlit label in **Load 1 Mode**
The Green LED lets you know that the Load 1 device is in on position .



PU Dome Backlit label in **Load 2 Mode**
The Red LED lets you know that the Load 2 device is in on position .

Dimming Instruction

- ▶ Press and hold the button for 5 seconds at off mode (Blue LED flash).
- ▶ Press the button to adjust the Blue Backlight level (3 levels)
- ▶ Wait for 3 seconds will set the light level automatically

REAR PLUG VIEW

OFF CAN BE BLUE BACKLIT - APPLY B+ TO TERM 4.
1ST PUSH - LIGHTS GREEN [LOAD 1 ON 2 OFF]
2ND PUSH - LIGHTS RED [LOAD 2 ON 1 OFF]
3RD PUSH - OFF

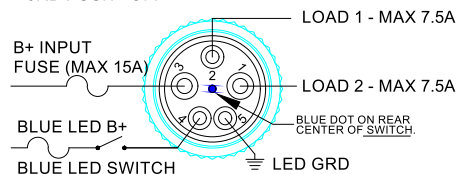

2 SPEED WIPER EXAMPLE

OFF CAN BE BLUE BACKLIT - APPLY B+ TO 4.
1ST PUSH - LIGHTS GREEN [LOW ON, HIGH OFF]
2ND PUSH - LIGHTS RED [HIGH ON, LOW OFF]
3RD PUSH - OFF

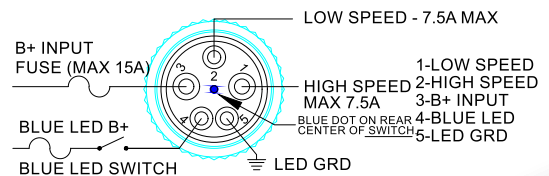

POS 1 & 3 ARE DEUTCH DTP [LARGE] FEM TERM
POS 2, 4, 5 ARE DEUTCH DP [SMALL] FEM TERM

9057-2123 Dual Momentary

OFF-[1 M ON] - [2 MON] GRE/RED

Operation

- ▶ Press and hold the button turns on Load 1 (LED turns Green).
- ▶ Press and hold the button turns on Load 2 (LED turns Red).
- ▶ Release the button to turns off Load 1 & 2 (LED turns Blue)



Laser Etched Actuator in **Daytime Mode**
LED light is off.



Laser Etched Actuator in **Nighttime Mode**
The Blue LED provides great visibility of the function switches and lets you know that the switches are in off position.



Laser Etched Actuator in **Load 1 Mode**
The Green LED lets you know that the Load 1 device is in on position.



Laser Etched Actuator in **Load 2 Mode**
The Red LED lets you know that the Load 2 device is in on position.

Dimming Instruction

- ▶ Press 6 times and hold the button for 5 seconds at off mode (Blue LED flash).
- ▶ Press the button to adjust the Blue Backlight level (3 levels)
- ▶ Wait for 3 seconds will set the light level automatically

REAR PLUG VIEW

OFF CAN BE BLUE BACKLIT - APPLY B+ TO TERM 4.
MOM 1ST PUSH - LIGHTS GREEN [LOAD 1 MOM ON]
MOM 2ND PUSH - LIGHTS RED [LOAD 2 MOM ON]
RELEASE - OFF

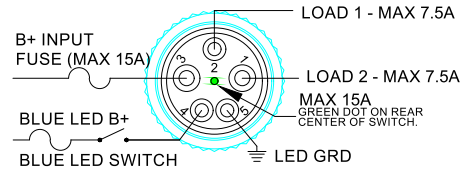

POS 1 & 3 ARE DEUTCH DTP [LARGE] FEM TERM
POS 4, 5 ARE DEUTCH DP [SMALL] FEM TERM
POS 2 SEAL

9057-2223 Dual Momentary

OFF-[1 M ON] - [2 MON] BLU/RED

Operation

- ▶ Press and hold the button turns on Load 1 (LED turns Blue).
- ▶ Press and hold the button turns on Load 2 (LED turns Red).
- ▶ Release the button to turns off Load 1 & 2 (LED turns Green)



Laser Etched Actuator in **Daytime Mode**
LED light is off.



Laser Etched Actuator in **Nighttime Mode**
The Green LED provides great visibility of the function switches and lets you know that the switches are in off position.



Laser Etched Actuator in **Load 1 Mode**
The Blue LED lets you know that the Load 1 device is in on position.



Laser Etched Actuator in **Load 2 Mode**
The Red LED lets you know that the Load 2 device is in on position.

Dimming Instruction

- ▶ Press 6 times and hold the button for 5 seconds at off mode (Green LED flash).
- ▶ Press the button to adjust the Green Backlight level (3 levels)
- ▶ Wait for 3 seconds will set the light level automatically

REAR PLUG VIEW

OFF CAN BE GREEN BACKLIT - APPLY B+ TO TERM 4.
MOM 1ST PUSH - LIGHTS BLUE [LOAD 1 MOM ON]
MOM 2ND PUSH - LIGHTS RED [LOAD 2 MOM ON]
RELEASE - OFF

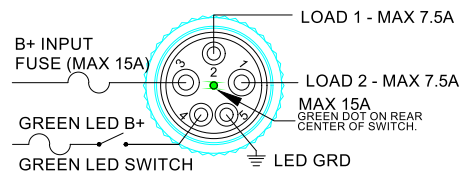

POS 1 & 3 ARE DEUTCH DTP [LARGE] FEM TERM
POS 4, 5 ARE DEUTCH DP [SMALL] FEM TERM
POS 2 SEAL

9051-0001 ~0188 Legend Code

Custom Text Available

0001	0002	0003	0004	0005	0006	0007	0008	0009	0010	0011	0012
0013	0014	0015	0016	0017	0018	0019	0020	0021	0022	0023	0024
0025	0026	0027	0028	0029	0030	0031	0032	0033	0034	0035	0036
0037	0038	0039	0040	0041	0042	0043	0044	0045	0046	0047	0048
0049	0050	0051	0052	0053	0054	0055	0056	0057	0058	0059	0060
0061	0062	0063	0064	0065	0066	0067	0068	0069	0070	0071	0072
0073	0074	0075	0076	0077	0078	0079	0080	0081	0082	0083	0084
0085	0086	0087	0088	0089	0090	0091	0092	0093	0094	0095	0096
0097	0098	0099	0100	0101	0102	0103	0104	0105	0106	0107	0108
0109	0110	0111	0112	0113	0114	0115	0116	0117	0118	0119	0120
0121	0122	0123	0124	0125	0126	0127	0128	0129	0130	0131	0132
0133	0134	0135	0136	0137	0138	0139	0140	0141	0142	0143	0144
0145	0146	0147	0148	0149	0150	0151	0152	0153	0154	0155	0156
0157	0158	0159	0160	0161	0162	0163	0164	0165	0166	0167	0168
0169	0170	0171	0172	0173	0174	0175	0176	0177	0178	0179	0180
0181	0182	0183	0184	0185	0186	0187	0188	0189	0190	0191	0192